

Loading lift tables Model 1S/1T

Loading Lift Tables improve factory and warehouse efficiency

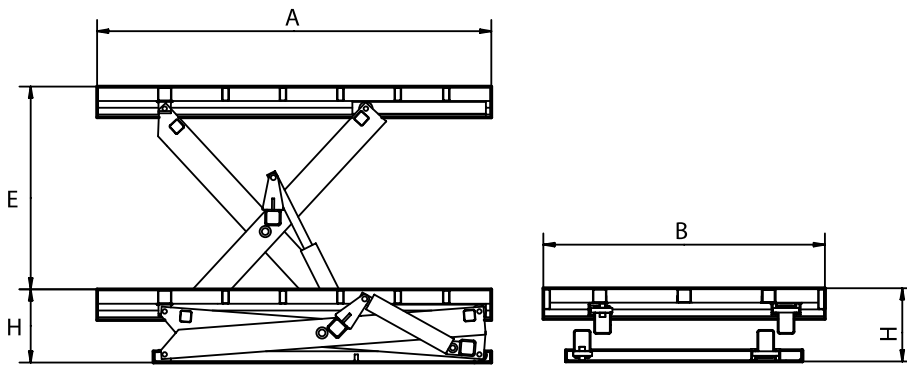

BOLZONI 



Range: 1000 Kg - 10000 Kg

- Top platform tread surface.
- Aluminium safety bar stops the descent of the platform in case of contact with obstructions.
- Single acting hydraulic cylinders equipped with hose safety valve, check valve and drainage.
- Low voltage "Hold-to-run" type control box.
- Safety props for safe servicing and maintenance operations.
- Removable lifting eye(s) to make easier handling and installation.
- Compliance with the Machinery Directive 2006/42CE and Safety Requirements for lift tables EN1570-1.

Ideal to load and unload vehicles by pedestrian or fork lift trucks without a loading dock.

Lift tables range designed to work with highest safety also with off-centered and moving loads.

CUSTOMIZED SOLUTIONS

Thanks to our experience and a wide range of accessories available, we are able to provide customized solutions and to comply with safety standards to suit all specific requirements.

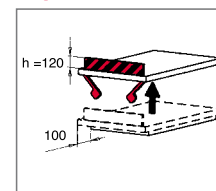

Roll-off stop

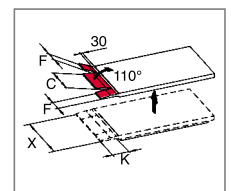

Manual bridge plate

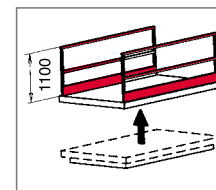

Safety handrails

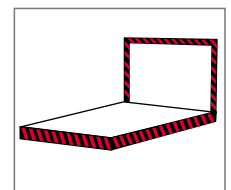

Goal posts

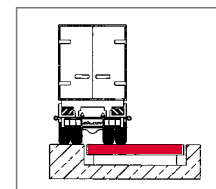

Top reinforcement for transit of truck

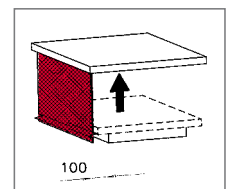

Mesh curtain

Model	Capacity	Stroke	Platform	Collapsed Height	Motor	Cylinder
	kg	E mm	A x B mm	H mm	Kw	n. diam.
A1 10 S010	1000	1600	2500 x 1200	350	1,5	1 90
A1 10 S120	1000	2000	3000 x 1500	350	3,0	2 90
A1 10 S130	1000	2000	3000 x 2000	350	3,0	2 90
A1 20 S110	2000	1600	2500 x 1500	350	3,0	2 90
A1 20 S120	2000	1600	2500 x 2000	350	3,0	2 90
A1 20 S130	2000	2000	3000 x 1500	350	3,0	2 90
A1 20 S140	2000	2000	3000 x 2000	350	3,0	2 90
A1 20 S150	2000	2000	3500 x 2000	350	3,0	2 90
A1 30 S110	3000	1600	2500 x 1500	380	3,0	2 90
A1 30 S120	3000	1600	2500 x 2000	380	3,0	2 90
A1 30 S130	3000	2000	3000 x 1500	380	4,0	2 110
A1 30 S140	3000	2000	3000 x 2000	380	4,0	2 110
A1 30 S150	3000	2000	3500 x 2000	400	4,0	2 110
A1 40 T000	4000	1600	2500 x 2000	500	4,0	2 110
A1 40 T010	4000	1600	3000 x 2000	500	4,0	2 110
A1 40 T020	4000	1800	3000 x 2000	550	4,0	2 110
A1 40 T030	4000	1800	3000 x 2400	550	4,0	2 110
A1 40 T040	4000	1800	3500 x 2400	550	4,0	2 110
A1 40 T050	4000	2000	3500 x 2000	550	4,0	2 110
A1 40 T060	4000	2000	3500 x 2400	550	4,0	2 110
A1 40 T070	4000	2000	4000 x 2400	550	4,0	2 110
A1 60 T000	6000	1500	2500 x 2000	550	4,0	2 120
A1 60 T010	6000	1800	3000 x 2000	600	4,0	2 120
A1 60 T020	6000	1800	3000 x 2400	600	4,0	2 120
A1 60 T030	6000	1800	3500 x 2400	600	4,0	2 120
A1 60 T050	6000	2000	3500 x 2000	600	4,0	2 120
A1 60 T060	6000	2000	3500 x 2400	600	4,0	2 120
A1 60 T070	6000	2000	4000 x 2400	600	4,0	2 120
A1 80 T000	8000	1500	2500 x 2000	600	4,0	2 130
A1 80 T010	8000	1800	3000 x 2000	650	4,0	2 130
A1 80 T020	8000	1800	3000 x 2400	650	4,0	2 130
A1 80 T030	8000	1800	3500 x 2400	650	4,0	2 130
A1 80 T050	8000	2000	3500 x 2000	650	4,0	2 130
A1 80 T060	8000	2000	3500 x 2400	650	4,0	2 130
A1 80 T070	8000	2000	4000 x 2400	650	4,0	2 130
A1 A0 T000	10000	1500	2500 x 2000	650	5,5	2 140
A1 A0 T050	10000	2000	3500 x 2000	700	5,5	2 140
A1 A0 T060	10000	2000	3500 x 2400	700	5,5	2 140
A1 A0 T070	10000	2000	4000 x 2400	700	5,5	2 140

Bolzoni promotes environmental sustainable research and innovation.

For a lower impact on the environment, Bolzoni lift tables are available with biodegradable hydraulic oil on request, and are all provided with high-efficiency electric motors IE3. Lift tables are painted with water based nontoxic solvent free paint.

Bolzoni SpA lift tables facility is certified with the Environment Certificate ISO 14001:2015, since 2006.

BOLZONI S.p.A.

VIA I MAGGIO,103 - CASONI DI PODENZANO -
29027 PIACENZA (ITALIA)

Tel. +39 0523 55 55 11 - Fax +39 0523 52 40 87

www.bolzonigroup.com - sales@bolzonigroup.com

BOLZONI