

**INSTRUCTION MANUAL FOR THE INSTALLATION, USE AND  
MAINTENANCE OF ERGOLIFT LIFT TABLES**

**ORIGINAL INSTRUCTIONS**



1. GENERAL INFORMATION	page. 3
1.1. PURPOSE AND CONTENT OF THE MANUAL	page 3
1.2. MANUAL AUDIENCE	page 3
1.3. MANUFACTURER LIABILITY	page 3
1.4. WARRANTY	page 4
1.5. MANUFACTURER IDENTIFICATION	page 4
1.6. MACHINE IDENTIFICATION	page 4
1.7. REQUIREMENTS AND STANDARDS	page 4
2. USE, AREAS OF USE, SOUND EMISSIONS	page 5
2.1. RECYCLING INSTRUCTIONS	page 5
3. TECHNICAL SPECIFICATIONS FOR STANDARD MODELS: ERGOLIFT	page 6
3.1. LOAD DISTRIBUTION	page 6
4. SAFETY INSTRUCTIONS	page 6
5. CHECKS UPON DELIVERY	page 7
6. PLATES AND LABELS ON THE TABLE	page 8
6.1. PLATE AND LABEL POSITIONS	page 9

7. TABLE OPERATION	page 10
8. INSTALLATION	page 11
8.1. CHECKS AT INITIAL START-UP	page 11
8.2. CONNECTION TO THE POWER SUPPLY	page 12
8.3. RATED CURRENT	page 12
8.4. APPLICATION OF SAFETY STRUTS	page 12
8.5. HOLE DESIGN	page 13
8.6. INSTALLING THE TABLE IN THE HOLE	page 14
9. COMPONENTS	page 14
9.1. HYDRAULIC SYSTEM	page 14
9.2. ELECTRICAL SYSTEM	page 15
9.3. HYDRAULIC VALVES	page 15
9.4. MECHANICAL COMPONENTS	page 15
9.5. OPERATIONS AFTER USE	page 16
9.6. Load limiter, warning light / sound	page 16
10. MAINTENANCE INSTRUCTIONS	page 16
10.1. SAFE MAINTENANCE	page 16
10.2. MAINTENANCE OPERATIONS	page 17
10.3. HYDRAULIC SYSTEM	page 17
10.4. ELECTRICAL SYSTEM	page 17
10.5. MECHANICAL COMPONENTS	page 17
10.6. LUBRICATION POINTS (if pins with grease nipples are installed)	page 18
11. TROUBLESHOOTING	page 19
11.1. PROBLEMS, CAUSES AND SOLUTIONS	page 19
12. RISKS CONNECTED WITH TABLE USE	page 20
12.1. RISK TABLE	page 20
13. SPARE PARTS	page 22
13.1. METHOD FOR REQUESTING SPARE PARTS	page 22
13.2. ORDERING SPARE PARTS	page 22
14. DISPOSAL AND SCRAPPING	page 22

## 1. GENERAL INFORMATION

### 1.1. PURPOSE AND CONTENT OF THE MANUAL

This manual describes the lift table, the functional technical specifications as well as instructions for its use, installation and maintenance.

The following documentation is also provided together with this manual:

CE declaration of conformity or declaration of incorporation pursuant to Annex VII B (Machine Directive 2006/42/EC).

All the documents are contained in transparent protective envelopes and are attached to the table.

### 1.2. MANUAL AUDIENCE

This manual is intended for:

- the manager of the plant, workshop or yard;
- installation personnel;
- maintenance personnel.

The manual must be kept by a person who is responsible for it, in a suitable location so that it can always be consulted and kept in good conditions.

If lost or damaged, replacement documentation can be requested, indicating the serial number of the table, either directly from BOLZONI S.P.A; or your local dealer. Anyone who uses the table must be fully informed of the information in the manual.

It is prohibited to make any changes to the manual without prior written authorisation from the manufacturer. The instruction manual and the manufacturer's declaration of conformity must be kept with the machine when it is sold to others.

### 1.3. MANUFACTURER LIABILITY

The instructions in this manual do not replace but supplement the obligations for complying with current safety and accident prevention regulations.

With reference to what is specified in this manual, BOLZONI S.P.A. declines all liability in the case of:

- installation of the table that does not comply with current national safety laws required according to table use
- improper use of the table according to national safety and accident prevention laws;
- failure to observe or incorrect observance of the instructions provided in the manual,
- mains voltage and power supply defects;
- unauthorised mechanical modifications;
- use by untrained personnel.

In order for the manufacturer warranty to be valid, as described in paragraph 1.4 of this manual, the customer must scrupulously observe the requirements set forth in the manual, and in particular:

- always work within the limits of use of the equipment;
- perform constant and careful maintenance;
- assign only operators with demonstrated ability and who have been suitably trained to use the table; only use original spare parts indicated by the Manufacturer.

#### 1.4. WARRANTY

BOLZONI S.P.A. Guarantees all tables for 12 months for a use of 8 hours a day for each working day, within the cycle/hour limits specified in the offer, starting from the shipping date. If used more than 8 hours per day the warranty period shall be reduced proportionately.

The warranty is limited to replacing the parts that the company deems defective due to material or machining defects ex BOLZONI S.p.A. works and does not include labour or travel costs for replacing said parts.

It is further understood that recognition of the warranty is void if the anomaly results from an inappropriate use of the product, if commissioning was not carried out according to BOLZONI S.p.A. specifications or if non-original parts have been used.

BOLZONI S.P.A. products are not guaranteed for uses that exceed the ratings stated on the plates and in the documentation.

All the equipment manufactured by BOLZONI S.p.A. is insured for any damage caused to third parties by defective parts or their malfunction; damage arising from improper use or misuse of the tables is not covered.

#### 1.5. MANUFACTURER IDENTIFICATION

This document entitled:

“INSTRUCTION MANUAL FOR THE INSTALLATION, USE AND MAINTENANCE OF LIFT TABLES” is only valid for tables manufactured by:

BOLZONI S.P.A.

29027 CASONI DI PODENZANO- PIACENZA (ITALY)

#### 1.6. MACHINE IDENTIFICATION

Each table has an identification plate that includes:

- manufacturer logo;
- name, company name and address of the manufacturer;
- table model;
- max capacity in Kg,
- year of manufacture;
- serial number;
- CE mark;
- working pressure;
- weight in Kg;
- IP protection.

#### 1.7. REQUIREMENTS, STANDARDS

BOLZONI lift tables were designed and built in order to guarantee maximum safety, reliability and duration. They comply with the basic requirements specified by the standard EN 1570 for lift tables. This European standard determines the safety requirements for lift tables used for lifting and/or lowering goods and/or people assigned to moving the material transported by the lift tables with maximum vertical travel of 3 m.

They may be manually operated or equipped with an electric motor.

Accessories can be installed to improve safety.

## 2. USE AND AREAS OF USE

The product is designed for use in dry, well lit rooms with moderate temperatures unless otherwise agreed upon with Bolzoni.

In addition to the safety devices of the table, additional safety measures may be necessary both for the table as well as for the surrounding work area.

It is recommended to carry out a risk analysis in accordance to what is set forth by the Machine Directive. See also the section “Risks connected with operation”.

These instructions must be made available to authorised personnel and must be kept with the product during its entire operative life.

BOLZONI lift tables can be used in many situations.

They are generally used for lifting/lowering loads. They are designed to be used on a flat and stable base or on the floor. They may be installed on the ground or inserted in a hole.

The floor/ground must resist to the combined weight of the table and the load.

The necessary information related to use and the load is included in this manual and refers to EN 1570.

During normal operation, sound emission must not exceed 70dB(A), measured at a distance of 1 metre and at a height of 1.6 from the greatest sound source.

### 2.1. RECYCLING INSTRUCTIONS

Reusable or recyclable materials were used to manufacture the lift tables. Worn tables must be disposed of by specialised companies, who will dismantle them and reuse the recyclable materials.

### 3. TECHNICAL SPECIFICATIONS FOR STANDARD MODELS: ERGOLIFT

#### 3.1. LOAD DISTRIBUTION

The maximum table capacity is indicated on the identification plate as well as on a label with large characters for immediate reference.

The maximum load refers to the load distributed uniformly over the entire table area.

Based on standard EN 1570, the basic standards are as follows:

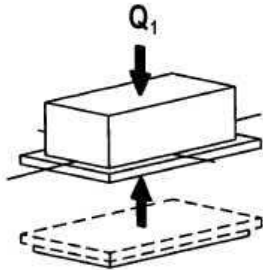

100% of the rated load (maximum load) distributed evenly over the entire table area.

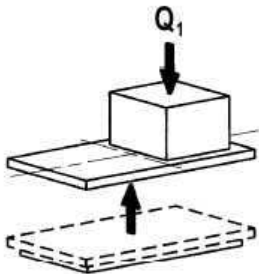

50% of the rated load (maximum load) distributed evenly over half the table length.

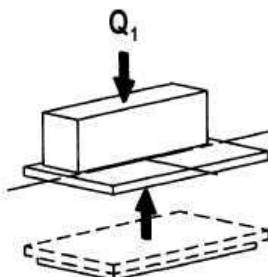

33% of the rated load (maximum load) distributed evenly over half the table width.

The technical specifications for each lift table are indicated in the order documentation and in the CE declaration of compliance.

#### 4. SAFETY INSTRUCTIONS

Bolzoni tables must only be used by authorised and suitably trained personnel. The operator is responsible for preventing accidents.

Use the Bolzoni tables only for the foreseen purposes and in completely safe conditions.

To prevent creating instability, do not overload the tables and try to position the load at the centre.

Check that the product is good condition before starting each work shift.

Maintenance and repair work must be carried out by qualified personnel.

If a fault is discovered, do not use the product until the malfunction has been resolved.

The operator must have a detailed view of the dangerous table parts and its load at each moment during vertical movement.

Never insert hands, arms, feet or other body parts or any type of object inside the lifted table.

Lower the table only after checking that no obstacles or people are located in the space under the table.

Never move the table with the load lifted, as it could overturn.

Never move the platform when the load is above the upper floor.

In the case of platforms with IE070 wheels or IE080 wheels and rudder, remove the load before performing any movement (see stickers on the floor side).

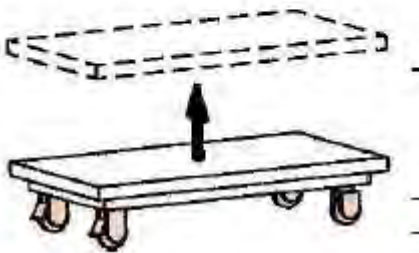
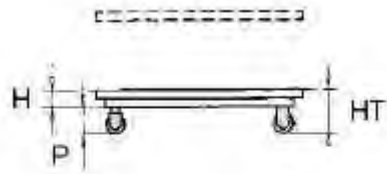

(IE070)

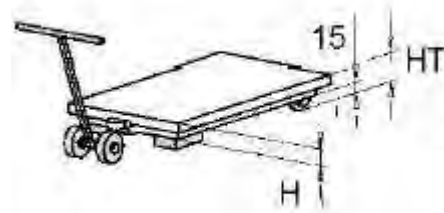

(IE080)

Make sure that the moving parts do not come into contact with adjacent objects.

Check that the table is used on a horizontal and level foundation.

Lifts with tipping must always be anchored to the ground.

Do not use Bolzoni tables as a work bench for welding, unless they have been specifically designed for this use.

Do not use the product in a potentially explosive environment.

Bolzoni tables are not electrically insulated, therefore they do not provide any protection for an operator who comes into contact with live wires or objects.

Maintain a safe distance from live wires and objects.

Do not alter or modify components of fundamental importance for purposes of safety and stability.

Loads must not be present during inspections and maintenance and repair work. Lock the lifting mechanism with safety struts.

## 5. CHECKS UPON DELIVERY

The table must be delivered completely closed and equipped with lifting eyebolts for transport and installation.

The position of the eyebolts must be visible and marked by suitable labels.

Make sure that the capacity (indicated on the data plate) of the forklift, crane or overhead crane is suitable for the weight of the table.

Keep the eyebolts if it is necessary to move the table.

Make sure that all parts of the table have been inspected by the manufacturer.

The internal inspection report confirms the positive result of the tests that were carried out.

Check that the hydraulic fluid is included and corresponds to the hydraulic oil required by ISO 46, or that it is ecological or suitable for food if this is foreseen in the contract documents

Check that the standard electrical system includes a three-phase 380/400 V, 50 Hz connection.

Also make sure that the control system (safety perimeter, solenoid valve, limit switch etc.) functions at a voltage of 24 V DC.

## 6. PLATES AND LABELS ON THE TABLE

The table was designed and built in compliance with the Essential Safety and Health Requirements, with a careful risk analysis; adhesive labels have been applied for the residual risks, indicating the danger.

Make sure upon delivery that the labels applied on the table are in a good condition, legible and in the correct language. Damaged or illegible labels should be replaced.



6.1. PLATE AND LABEL POSITION

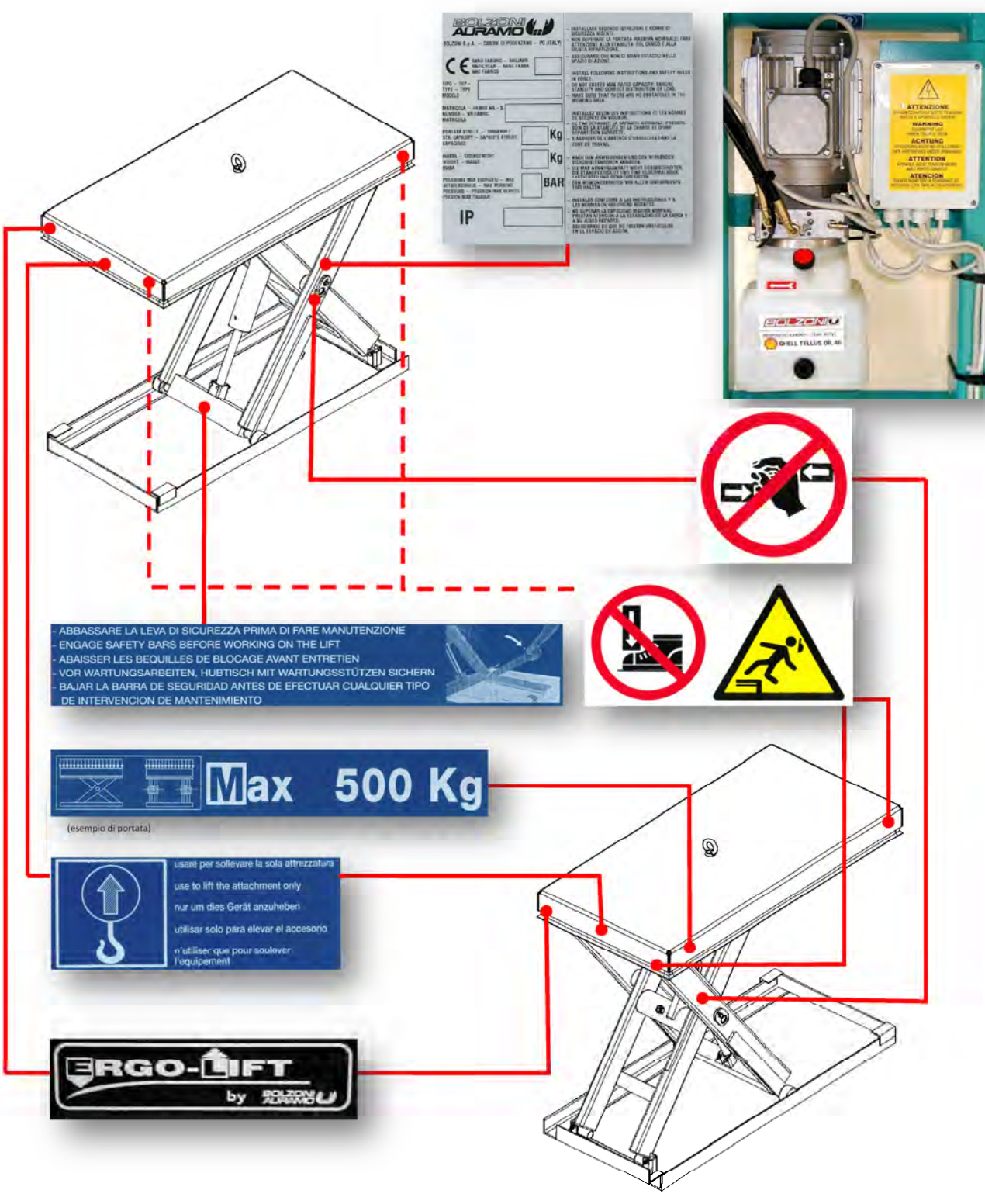



**BOLZONI ALPAMD**  
 BOLZONI S.p.A. - SEZIONE DI PORDENONE - PD (ITALY)

CE MARKING - BOLZONI  
 MODEL -  - MAX HEIGHT -   
 TYPE -  - TYPE -   
 MODEL -

MAX CAPACITY -  Kg  
 MAX CAPACITY -  Kg  
 MAX CAPACITY -  BAR

IP











- ABBASSARE LA LEVA DI SICUREZZA PRIMA DI FARE MANUTENZIONE  
 - ENGAGE SAFETY BARS BEFORE WORKING ON THE LIFT  
 - ABAISSER LES BEQUILLES DE BLOCAGE AVANT ENTRETIEN  
 - VOR WARTUNGSARBEITEN, HÜBTISCH MIT WARTUNGSSTÜTZEN SICHERN  
 - BAJAR LA BARRA DE SEGURIDAD ANTES DE EFECTUAR CUALQUIER TIPO DE INTERVENCIÓN DE MANTENIMIENTO

 **Max 500 Kg**

(esempio di portata)

 usaro per sollevare la attrezzatura  
 use to lift the attachment only  
 nur um dies Gerät anzuheben  
 utilizar solo para elevar el accesorio  
 n'utiliser que pour soulever l'équipement

**ERGO-LIFT**  
 by **BOLZONI**

## 7. TABLE OPERATION

The table must be connected to the electric network. Check that the supply voltage is compliant with the electric network.

The control push-button panel for the table must be positioned so that the operator has a good view of the table and the load.

BOLZONI S.P.A. tables must be used in completely safe conditions while paying maximum attention.

The control functions are lifting-lowering and emergency, and can be activated by pressing the push-buttons. The table stops once it reaches a position if equipped with a lifting limit switch, otherwise it stops mechanically at the end of cylinder travel.

Check the operation of the safety perimeter. If the safety perimeter is activated, the problem that caused the stop must be identified and resolved.

To restart the lowering operation, press the lift push-button to release the table.

BOLZONI S.P.A. tables that are equipped with an electrically operated non-return valve (normally closed) fit on the cylinder.

Standard EN 1570 foresees that the lifting and lowering table speed must not exceed 150 mm/sec.

There is a flow control valve on BOLZONI S.P.A. tables that limits the lowering speed.

The control push-button panel includes an emergency stop push-button that remains pressed when activated and all electrically activated movements are blocked.

After using it, lower the table to the minimum position and disconnect the power supply.

Before lowering the table, make sure not to risk damaging people or property and that there are no obstacles that would limit the descent.

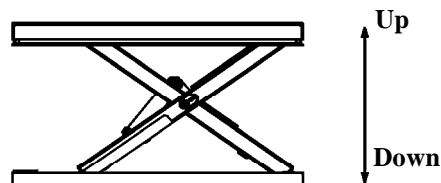

## 8. INSTALLATION

**NB: Before installing the table, the eyebolts must be removed.**

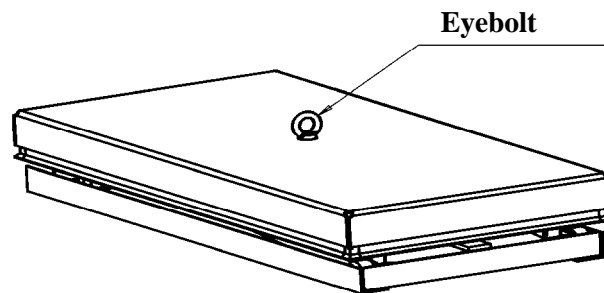

The table must be installed by specialised personnel and must comply with current safety and accident prevention standards related to the specific use of the table.

Before installing the table, check the condition and completeness of the equipment.

During the installation procedure, the table must be completely unloaded.

It is necessary to fit a cut-off device on the power supply line, which must be accessible for the operator during operation.

The table control unit must have an emergency stop device.

Check that the floor where the table is installed is perfectly flat.

### 8.1. CHECKS AT INITIAL START-UP

Make sure that nothing was damaged during transport.

Do not carry out lifting operations on the safety perimeter.

Check that the safety perimeter is working properly and that its lifting causes the safety microswitch to trip.

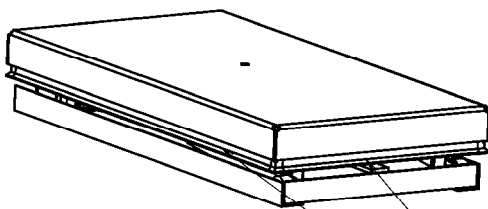

**Do not tamper with the safety perimeter**

## 8.2. CONNECTION TO THE POWER SUPPLY

For the connection to the electric network, insert the power supply cable plug, which consists of four wires: three phases and ground.

The EEC pin and network insulator are not included in the supply.

If the motor starts but the table does not lift, invert the two phases. It is important that the motor does not operate for too long in the incorrect direction to prevent damaging the pump.

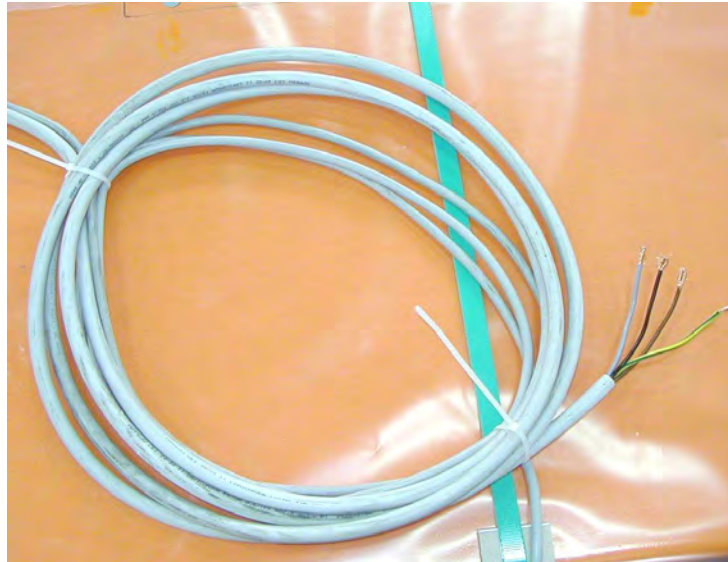

## 8.3. RATED CURRENT

Check the type of power supply, voltage and rated power of the motor.

KW= Rated motor power

In= Rated current

A= Network fuse

If the power supply is single phase, the motor may have greater power.

## 8.4. APPLICATION OF SAFETY STRUTS

Safety struts must be applied during any operation carried out under or near the table. This also applies to installation, maintenance and inspections as well as for all repairs.

**The safety struts must be installed on both sides.**



## 8.5. HOLE DESIGN.

Bolzoni S.p.A. supplies the executive design for the hole. The dimensions shown below are only approximate and any accessories could involve changes to the dimensions. It is important that the floor is flat and stable and that the installation area or hole is free from obstructions.

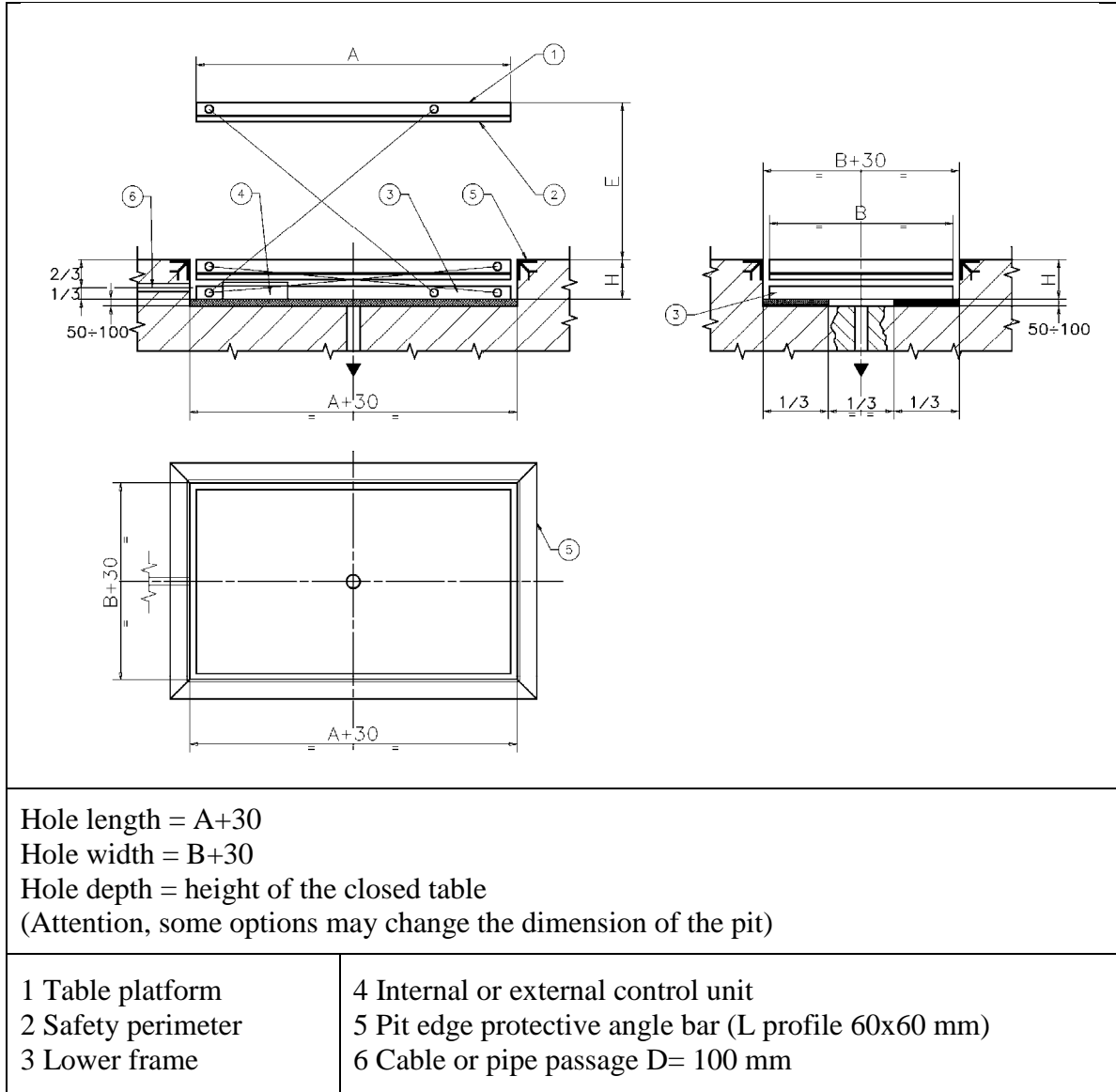

## 8.6. INSTALLING THE TABLE IN THE HOLE (INTERNAL OR EXTERNAL CONTROL UNIT)

Check that the diagonals of the hole are the same and that their dimensions are 30 mm greater than those of the table.

It is important that the lower surface of the hole is perfectly parallel to the upper surface of the floor to ensure proper table operation. For small differences in level, adjust the adjustable mechanical struts, or use shims.

Check for the presence of the supply pipe and cable duct and any water collection pit, for external installation.

The operator is obliged to first check before inserting the table in the hole that no people and/or animals are located near the hole.

Temporarily connect the control unit to the network and position the cable so it does not hinder inserting the table in the hole.

Remove the eyebolts, lift and lower the safety bars.

Make the network connection, passing the cables and pipes in the duct.

Operate the table and test the functions.

Never exceed the maximum descent speed permitted for a full load.

Check the operation of the safety perimeter on all sides.

The push-button panel or the control unit (if external) must be positioned so that the operator always has a detailed view of the table and the load when the table is operating.

## 9. COMPONENTS

### 9.1. HYDRAULIC SYSTEM

The BOLZONI S.P.A. lift tables are equipped with internal or external hydraulic power packs. The single acting hydraulic system corresponds normally to what is shown in the attached hydraulic diagram. A N.C. electrically activated non-return valve is fit on the cylinders.

For proper table operation, make sure that the type of oil foreseen by standard ISO 46 is used and that the entire system is clean.

Considering the versatility of the tables, the hydraulic system is often customised.

#### Hydraulic power pack

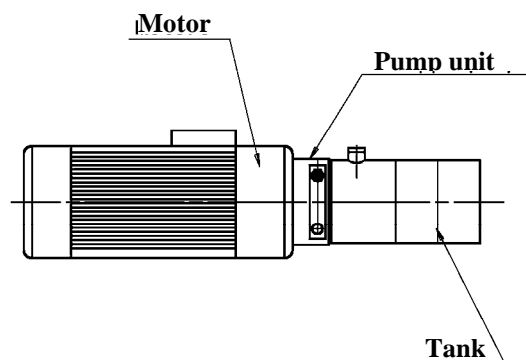

## 9.2. ELECTRICAL SYSTEM

The lift tables have a three-phase or single-phase connection with voltage to be defined. The network disconnecting switch is not supplied by BOLZONI SPA, and it must be fitted by the electrician upon installation. The power supply cable must be connected to the terminals of the disconnecting switch.

The wiring diagram is included in this manual.

Considering the versatility of the tables, the electrical system is often customised.

## 9.3. HYDRAULIC VALVES

### Electrically activated non-return valve fit on the cylinders.

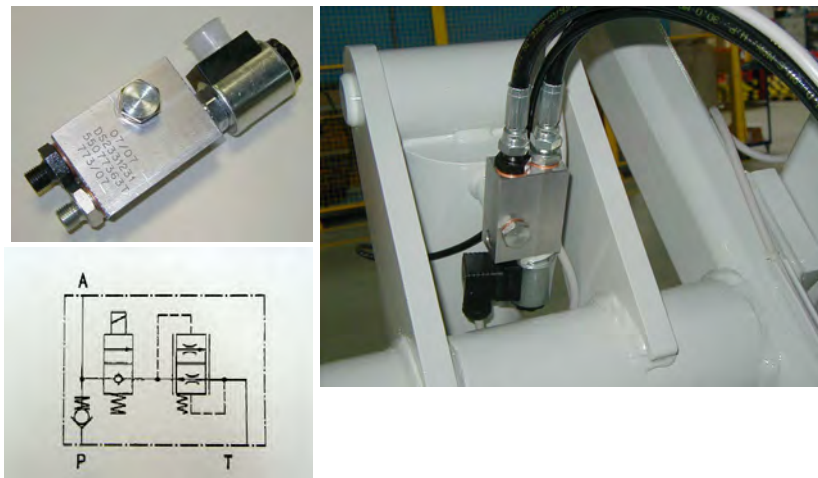

### Safety valve fit directly on the cylinder bulkhead.

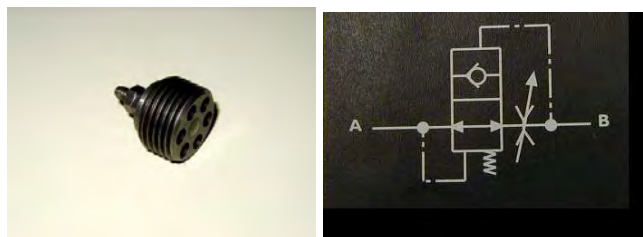

## 9.4. MECHANICAL COMPONENTS

The BOLZONI SPA lift tables consist of:

- An upper platform with a safety perimeter to automatically stop downward travel in the case of interference with foreign bodies.
- A pair of scissor arms placed apart from each other to prevent shearing hazards during movement.
- One or more single acting hydraulic cylinders with normally closed non-return valves that prevent the table from descending if hydraulic pipe breaks.
- Base frame for placing the table on the ground.
- Mechanical obstruction bars for carrying out the maintenance operations in safety.

- Eyebolts for lifting and positioning the table.

Lifting is carried out by the single effect cylinders located between the pair of scissor arms that provide the lifting force. The lifting and descent movements are mechanically synchronised through the connection between the platform, arms and frame.

The joints in the standard tables have self-lubricating bushings. In the case of intense use at high speed, the joints contain pins with grease nipples and the lubricating bushings.

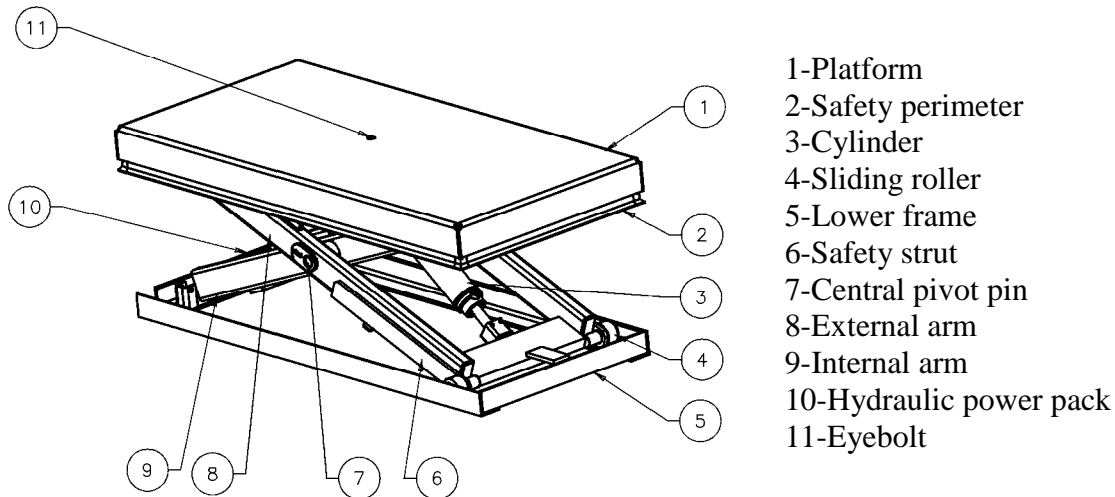

## 9.5. OPERATIONS AFTER USE

After completing work, it is recommended to lower the table to the minimum position.

If the table is left in a lifted position, the level may vary due to different reasons:

- The volume of oil changes due to temperature variations.
- Leaks in the valves, pipes or unions
- Leak in the cylinder
- 

## 9.6. Load limiter, warning light / sound

All lift tables where the operator may be on board must be equipped with a load limiter in order to prevent overloading. This device prevents the lift table from moving when it is overloaded and comes with a warning light and sound (fig. 18) so that it can be seen and heard by the operator on the landing above.

## 10. MAINTENANCE INSTRUCTIONS

### 10.1. SAFE MAINTENANCE

Before carrying out any maintenance, make sure that the safety bars located at the base of the sliding arms are lowered.

Before carrying out any maintenance work on the table, make sure that the load has been removed from the upper platform.

When working on the mechanical and electrical parts, the main disconnecting switch must be deactivated.

If a large or significant repair is carried out, the table must be reinspected in compliance with standard EN 1570, Annex C.



## 10.2. MAINTENANCE OPERATIONS

Maintenance should be performed every 500 hours of operation unless the operating and environmental conditions require more frequent maintenance.

Evaluate maintenance intervals with a BOLZONI SPA representative.

The inspections and maintenance operations must be carried out by expert personnel with the table unloaded.

## 10.3. HYDRAULIC SYSTEM

Check the level of oil in the tank, top up the oil if necessary with SHELL TELLUS OIL 46 or equivalent (data plate near the cap). If the oil is dirty, change it.

Check for any leaks in the oil tank.

Inspect the hydraulic pipes and unions for any leaks or damage.

Check the cylinders; a possible oil leak makes it necessary to replace the gaskets and carefully check the stem.

Check the seal on the valve and cylinders that must guarantee a maximum vertical lowering of the table of 5 mm in 10 minutes with the platform completely lifted and with a maximum load (EN 1570).

## 10.4. ELECTRICAL SYSTEM

Inspect and test the electrical functions.

Check that the cables and wires are intact. Fix them if necessary.

Check the operation of the safety perimeter microswitches and replace them if necessary.

## 10.5. MECHANICAL COMPONENTS

Check that all sliding wheels and pivot pins are correctly fitted.

Keep the roller rolling tracks clean, do not grease them.

Check the wear of the bushings in the pivots and in the sliding rollers, checking clearance.

Check for cracks or breaks in the welding.

Check that the safety perimeters are intact and not damaged.

Check that the table is stable.

Check that all labels are attached and clearly legible.

## 10.6. LUBRICATION POINTS

If the table is equipped with grease nipples in the pivots, lubricate using high quality grease (SHELL ALVANIA GREASER 3 or corresponding).

Perform the lubrication with the table unloaded and with the safety bars lowered.

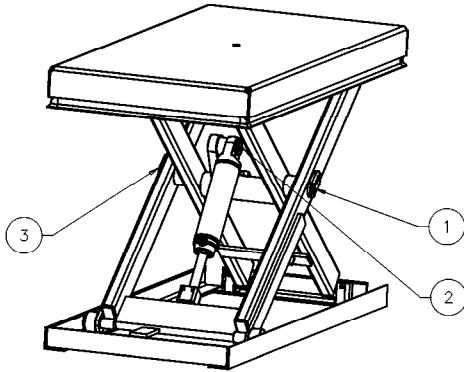

- 1-Central pivot
- 2-Cylinder coupling pin (Elevated cycles)
- 3-Central pivot

## 11. TROUBLESHOOTING

The troubleshooting procedure must be carried out by expert personnel.

In most cases, authorised personnel is an expert installer, specifically trained in mechanical parts. BOLZONI SPA technical personnel must intervene if any difficulties are encountered when troubleshooting or if the defect is different than those listed below.

While carrying out the inspections or working underneath, position the safety bars.

### 11.1. TROUBLESHOOTING

<b>Fault</b>	<b>Cause</b>	<b>Remedy</b>
The table does not lift; the motor rotates normally.	Eyebolts still fitted	Remove them
	Retaining solenoid valve blocked in the open position	Check the operation of the cursor and the solenoid; replace damaged parts.
	Table overloaded.	Remove the load.
	The motor is rotating in the opposite direction.	Invert two phases.
The table does not lift; the motor does not rotate.	The ascent limit switch, if fitted, is damaged.	Replace.
		Wait for the motor to cool, check the motor power supply and absorption.
The table does not descend.	The descent limit switch, if fitted, or a perimeter micro are damaged.	Replace.
	The retaining solenoid valve is blocked or the solenoid is damaged.	Remove the retaining solenoid valve and clean it carefully. If necessary, replace the damaged parts.
	The safety perimeter was triggered.	Restore operation by pressing the "UP" push-button on the push-button panel.
The table goes down also in the stop position. N.B. Standard EN 1570 foresees maximum vertical lowering of 5 mm in 10 min with the platform completely lifted and with the maximum load)	The retaining solenoid valve lets oil seep through.	Remove the retaining solenoid valve and clean it carefully. Replace if necessary.
	The lifting cylinder gaskets are worn.	Check the gaskets and replace if necessary.
At the end of stroke, the table positions itself differently than expected.	The ascent end of stroke microswitch, if fitted, is damaged or out of calibration (the table arrives to the mechanical end of stroke with the cylinder).	Clean and recalibrate the microswitch; replace it if necessary.

## 12. RISKS CONNECTED WITH TABLE USE

Some common situations of table use are listed below with some examples of connected risks.  
Some examples of preventive or corrective actions are provided.

### 12.1. RISK TABLE.

Situation of use	Risk	Action/example
General	Unauthorised use	Signs Training-Instructions Control unit with locking device
	Unauthorised access under the lifted table	Training-Instructions Signs Protection with grids Protective bellows Barriers
	Use while overloaded	Signs Training – Instructions Respect load distribution and position
	Management	Signs Training-Instructions Control devices Emergency stop
	Standards	Mandatory inspections Standards concerning safety and health Standards concerning constructions and building Fire protection Risk assessment

Situation of use	Risk	Action/example
Environmental factors	Cold	Type of oil Limits for minimum temperature Gasket and pipe material
	Hot	Type of hydraulic fluid Limits for maximum temperature Gasket and pipe material
	Fire	Type of hydraulic fluid (water, glycol or non flame propagating oil) Limits for maximum temperature
	Explosion hazard	EEX components ATEX directive
	Environmental risks	Biodegradable oil
	Supplies	Food grade hydraulic fluids Surface treatment resistant to detergents
	Humidity	Class of electrical protection (IP) Anticorrosion protection (surface treatment, bushings, cylinders)
	Dust	Class of electrical protection (IP) Protection of mechanical parts, control unit and electric motor
External use	Weather conditions Wind	

## 13. SPARE PARTS

### 13.1. METHOD FOR REQUESTING SPARE PARTS

The tables are designed and built so that they do not require, if used correctly and suitable maintenance is performed as described in this manual, spare parts due to faults and breakage. Some parts subjected to wear are identified in the spare parts list attached to this manual. It is mandatory that only original spare parts are used, requesting them directly from: BOLZONI SPA.

The use of non-original spare parts invalidates the warranty and could jeopardise the proper operation of the table.

### 13.2. ORDERING SPARE PARTS

When ordering spare parts, always indicate the data specified on the machine plate.

## 14. DISPOSAL SCRAPPING

If the table is to be scrapped, its parts must be disposed of separately according to their different types (e.g. metals, oils and lubricants, plastic and rubber, etc.), using if possible special companies authorised for the purpose and in any case in compliance with what is specified by laws concerning the disposal of solid industrial waste.

